

# SMART CARB®

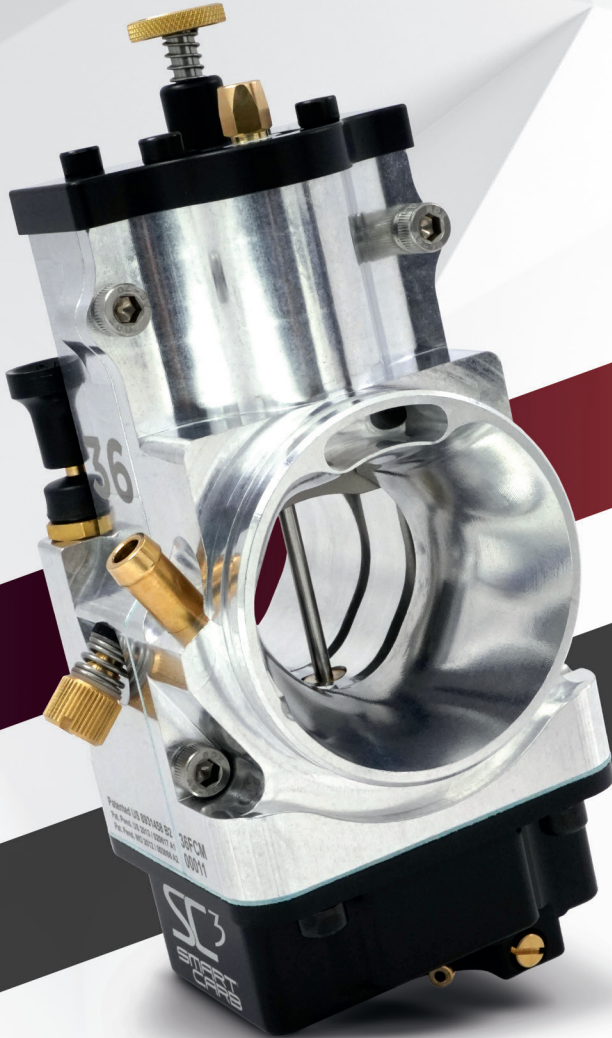

User Installation  
& Tuning Manual

36/38/40mm

**READ THIS MANUAL CAREFULLY &  
THOROUGHLY BEFORE INSTALLATION & TUNING**

Copyright 2025 SmartCarb Fuel Systems, Inc.

# Contents

---

<b>Product Information</b>	<b>3</b>
<b>SmartCarb® Introduction</b>	<b>6</b>
<b>Notes, Cautions, &amp; Warnings</b>	<b>9</b>
<b>SmartCarb® Installation</b>	<b>10</b>
<i>Required Tools</i>	<i>11</i>
<i>Removing The Stock Carburetor</i>	<i>13</i>
<i>SmartCarb® Inspection</i>	<i>15</i>
<i>SmartCarb® &amp; Slide Installation</i>	<i>16</i>
<b>SmartCarb® Tuning Philosophy</b>	<b>23</b>
<i>Clicker Adjustments</i>	<i>24</i>
<i>Idle Set Screw Adjustments</i>	<i>26</i>
<i>Finding a Balance</i>	<i>28</i>
<b>SmartCarb® Operation &amp; Tuning</b>	<b>29</b>
<i>Tuning Preparation</i>	<i>29</i>
<i>Starting Procedures</i>	<i>31</i>
<i>Tuning Idle Quality</i>	<i>33</i>
<i>Tuning Low Speed</i>	<i>42</i>
<i>Tuning Top End</i>	<i>44</i>
<b>Changing the Metering Rod</b>	<b>48</b>
<b>Checking/Adjusting Float Level</b>	<b>51</b>
<b>SmartCarb® Maintenance</b>	<b>55</b>
<i>Cleaning the SmartCarb®</i>	<i>55</i>
<i>Maintenance Requirements</i>	<i>56</i>
<b>Tuning Notes</b>	<b>57</b>

# Product Information

---

## Limited Warranty

SmartCarb Fuel Systems, Inc (SCFS) SmartCarb® carburetors and all parts including kit components are warranted to the original purchaser to be free of manufacturing defects in materials and workmanship for a period of six (6) months from the original shipping date. Any part that fails to conform to these conditions will be repaired or replaced at the discretion of SCFS upon receipt of the defective part within the six (6) month warranty period.

In the event that a part has been determined to be defective, SCFS must be notified prior to the return of the defective part. A Return Merchandise Authorization number (RMA) must be obtained prior to the return of any defective parts.

A part that is suspected to be defective must not be replaced without prior authorization from SCFS. SCFS will not be liable for any consequential or incidental damages resulting from the failure of any SCFS part, the breach of any warranties, the failure to deliver, delay in delivery, delivery in nonconforming condition, or for any other breach of duty between SCFS and a customer.

All warranties will be void under any of the following conditions:

- Merchandise was improperly installed or used in an abnormal application.
- Merchandise has been modified or altered in any way.

Any modifications to these products will void any certification and all warranties they may carry.

SCFS SC3 SmartCarb® carburetors are designed to replace conventional spigot mount top-pull carburetors and will fit most intake manifolds and conventional air boxes that use Mikuni VM, TM, and Keihin PE, PJ, and PWK series carburetors.

All SCFS SmartCarb® carburetors are designed for off-road or racing applications only (except those certified to meet CARB and EPA on-highway use in the U.S.) and are intended for the experienced rider. Any modification to, removal of, or operation of the vehicle without the factory equipped carburetor, manifold, airboot and air cleaner in place may void the factory vehicle warranty. Check your owner's manual or your local dealer for details. In addition, the installation of any part designed for off-road or racing may violate certain federal, state, and local regulations.

It is the sole responsibility of the user to determine the suitability of the product for his/her use, and the user shall assume all legal, personal injury risk and liability and all other obligations, duties and risks associated therewith.

# Product Information

---

## Limitations of Liability

- No unapproved modifications can be made to the product for the warranty to remain in effect.
- No reimbursement is provided for towing, loss of time, loss of use, inconvenience, or consequential damages.
- Warranty covers only parts and labor due to manufacturer defect. Damage due to misuse or neglect are not covered by this Limited Warranty.
- Warranty is non-transferable after product's initial sale.
- Warranty does not cover improper repair or misdiagnosis of problem.
- Warranty will not apply to products outside of the Warranty Period.
- Transportation damage, improper storage, or neglect of product and special or consequential damages or lost profits will not be covered by SCFS under warranty.
- Warranty will not be extended to "demonstration" or "discounted" products after sale.
- Normal maintenance expenses are not covered by this Limited Warranty, and are the sole responsibility of Buyer.
- This Limited Warranty does not extend to damage caused by flood, fire, earthquake, tornado, or other natural disasters or "Acts of God."

## Disclaimer

Except where such disclaimers and exclusions are specifically prohibited by applicable law, THE FOREGOING LIMITED WARRANTY SETS FORTH THE ONLY GUARANTEES OR WARRANTIES APPLICABLE TO THE PRODUCT AND SAID LIMITED WARRANTY IS GIVEN EXPRESSLY AND IN LIEU OF ALL OTHER WARRANTIES, EXPRESS OR IMPLIED, OF MERCHANTABILITY OR FITNESS FOR A PARTICULAR PURPOSE AND ALL OTHER WARRANTIES ARE DISCLAIMED BY SCFS. Oral statements about the product made by SCFS's dealers, or statements contained in SCFS's or others' general advertising, pamphlets, brochures, or other printed matter, do not constitute warranties of SCFS or SCFS's authorized dealers.

# Product Information

---

## **Buyer's Remedies**

Except where such disclaimers and exclusions are specifically prohibited by applicable law, BUYER'S SOLE AND EXCLUSIVE REMEDY AGAINST SCFS UNDER THIS LIMITED WARRANTY SHALL BE LIMITED TO THE APPLICABLE REMEDIES AND WARRANTIES SET FORTH HEREIN AND NO OTHER REMEDY (INCLUDING BUT NOT LIMITED TO THE RECOVERY OF DIRECT, INCIDENTAL, SPECIAL, INDIRECT OR CONSEQUENTIAL DAMAGES, INCLUDING BUT NOT LIMITED TO LOST PROFITS, LOST SALES, INJURY TO PERSON OR PROPERTY, OR ANY OTHER LOSS) SHALL BE AVAILABLE TO BUYER OR ANY OTHER PERSONS OR ENTITIES, WHETHER BY DIRECT ACTION, FOR CONTRIBUTION OR INDEMNITY, OR OTHERWISE. This exclusive remedy shall not be deemed to have failed its essential purpose as long as SCFS is willing and able to carry out the terms of the Limited Warranty as set forth herein.



**SmartCarb Fuel Systems, LLC is always ready to answer questions or inquiries over the phone or through email.**

9900 E 56th St, Raytown, MO 64133

Phone: (816) 255-2328

Email: [info@smartcarb.com](mailto:info@smartcarb.com)

Web: [smartcarb.com](http://smartcarb.com)

# SmartCarb® Introduction

## The SmartCarb®

The SmartCarb® SC3 is a precision air and fuel metering instrument that provides extremely fine fuel atomization, precise air/fuel mixture control, and ambient air density compensation. All of these innovative features are delivered in a single-circuit, flat-slide, variable venturi, jet-less carburetor. See below for a list of features and their benefits:

### ***Single-Circuit Flat-Slide Design***

- No Jets
- No Accelerator Pump
- Easy External Adjustments

### ***Proprietary High-Velocity Venturi***

- Excellent Throttle Response
- Linear Throttle Control

### ***Precision Flat-Ground Metering Rod***

- Ultra-Fine Fuel Atomization (+8-10% HP)
- Unparalleled Fuel Economy (+25-30%)

### ***Float Bowl Pressurization Circuit***

- Ambient Air Density Compensation
- Automatic Altitude Mixture Correction
- Internally Vented & Sealed From Atmosphere (no fuel spillage)
- Lowest Evaporative Emissions Ever Tested in a Carburetor

### ***Simple External Adjustments***

- Clicker Adjuster (top)
- Idle Set Screw (side)
- Manual Choke (back)
- Float Bowl Drain (bottom)



# SmartCarb® Introduction

---

## How It Works

The SmartCarb® carburetor from SmartCarb Fuel Systems Inc is the direct result of more than 55 years of development of the single-circuit flat-slide carburetor. Its pedigree comes from the long line of William “Red” Edmonston American-designed carburetors, including the Posa-Fuel, Lake Injector, the Lectron® carburetor, Ei Blue Magnum, and Quicksilver.

The SmartCarb® combines all of the best features found in earlier flat-slide, variable venturi carburetor designs and incorporates design features perfected by SmartCarb Fuel Systems, Inc and not found on any of its predecessors, making it a real world solution to satisfying a variety of emissions regulations and OEM performance requirements in small engine applications.

## ***Superior Fuel Atomization***

The extremely fine fuel atomization provided by the SmartCarb® exceeds that of electronic fuel injection (EFI), which is a result of the SmartCarb’s proprietary venturi shape and features that are designed to accelerate airflow past a precision flat-ground metering rod. This highly accelerated airflow results in a strong signal to the metering rod which produces fuel droplets that are much smaller and more highly atomized than the fuel droplets produced by modern EFI systems and other conventional carburetors.

Ultra-fine atomization means a more complete and significantly cleaner combustion burn, resulting in lowered emissions, greater fuel economy, and increased power. By effectively atomizing the fuel prior to combustion, more of the fuel is consumed during the combustion process. In addition, smaller fuel droplets mean more of the fuel’s potential energy is released during combustion, leading to an increase in power. Extensive testing has yielded average power increases of between 8% and 10%.

## ***Air Density Compensation***

Ambient air density compensation is accomplished by the SmartCarb® carburetor’s internal float bowl venting feature. Internal float bowl venting maintains a steady atmospheric pressure on the fuel in the float bowl proportional to the atmospheric pressure in front of the venturi. This action is enabled by a scoop located at the top of the venturi that vents into the float bowl. The constant yet continuously equalized pressure between the venturi and the float bowl provides efficient air/fuel mixing within the SmartCarb®, regardless of altitude, air temperature, or other changes in air density, even including artificial factors like turbo boost.

# SmartCarb® Introduction

---

## How It Works (continued)

### ***Sealed System***

All SmartCarb® carburetors come equipped with a check-valve system that operates by buoyancy and gravity to seal the internal vent passages in the event of flooding or laying the engine on its side. These check-valves not only prevent fuel from flooding into the engine, they effectively seal the fuel within the carburetor instead of spilling it out onto the ground through external vent lines found in conventional carburetors. This is a smart solution to an age-old problem, without any compromises to performance.

### ***Track or Trail-Side Tuning In Seconds***

SmartCarb® carburetors are highly, yet easily adjustable via the Clicker Adjuster on top of the carburetor and the Idle Set Screw on the side. Both adjusters are readily accessible by hand without having to remove the carburetor from the engine or even getting off the vehicle in most cases. Making mixture adjustments is as simple as turning the engine off, opening the throttle all the way, and pushing in and twisting the Clicker Adjuster to make fine mixture adjustments. And because the SmartCarb® compensates for ambient air density, once the right mixture adjustment setting is found, it can be left alone and the SmartCarb® will do the rest, regardless of altitude or temperature changes. No more jetting!



# Notes, Cautions, & Warnings

## **Notes, Cautions, & Warnings**

Statements in this manual preceded by these words are very important. Please read and consider them carefully.

### **NOTES:**

Give helpful information that can make Installation and Tuning easier.



### **CAUTIONS:**

Indicate a possibility of damage to the vehicle if instructions are not followed.



### **WARNINGS:**

Indicate a possibility of personal injury or vehicle damage if instructions are not followed.

# SmartCarb® Installation

## Before You Begin

### ***NOTE:***

Due to the wide variety of manufacturers, models, and applications, this manual is intended only as a general guide.



### ***CAUTION:***

A moderate level of mechanical skill is required to install the SmartCarb®. After carefully reading these instructions, if you have any doubts, we recommend that you have a professional install the SmartCarb® for you. If you install the SmartCarb® yourself we recommend that you also use the applicable shop manual for your motorcycle or recreational product for reference.

### ***NOTE:***

SmartCarb® carburetors are set at the factory with baseline settings specific to the vehicle detailed to us by the original purchaser. Do not make any adjustments to the SmartCarb® before installation. If adjustments have been made prior to or during installation, tuning the SmartCarb® may be more difficult. We recommend that you leave the SmartCarb® set at the factory settings located on the back of the Quick Start Guide included with your purchase.

# SmartCarb® Installation

## Required Tools

The tools required to remove the stock carburetor and install and service the SmartCarb® are listed and shown below:

- 2.5mm, 3mm, & 4mm Allen wrenches
- Needle-nose pliers
- Small adjustable wrench
- “C” clip or snap ring pliers (internal)
- 1/2” slotted screwdriver
- 1/4” slotted screwdriver
- #2 Phillips screwdriver
- Shop manual for your bike, off-road, or dual purpose recreational vehicle
- Measuring calipers



# SmartCarb® Installation



## **WARNINGS:**

SmartCarb Fuel Systems SmartCarb® carburetors require the use of the factory or a factory style replacement throttle cable assembly in good working order to assure positive opening and closing of the throttle valve or slide.

Upon installation, the throttle cables should be routed freely (without sharp bends) between the throttle and the carburetor. The throttle cables must not be pinched by the installed gas tank, nor should they be pinched, pulled, or restricted by the motorcycle bodywork and/or the fork assembly when the handlebars are turned through their full range of motion.

Gasoline is extremely flammable and is explosive under certain conditions. Before attempting to install or service your SmartCarb®, please follow these fire safety procedures:

- 1.** Make sure your work area is well ventilated and free from any source of flame or sparks, i.e., appliances with pilot lights or self igniters such as water heaters or furnaces.
- 2.** Never look directly into the carburetor while the engine is running; injury may result from a possible backfire.

# SmartCarb<sup>®</sup> Installation

## Removing the Stock Carburetor

- A.** Check the fuel valve, making sure it is turned completely OFF.
- B.** Disconnect or reroute the vacuum lines (if applicable) and fuel lines from the carburetor. Again, make sure the fuel valve is turned OFF.
- C.** Disconnect the battery (if equipped) to eliminate the possibility of sparks or accidentally engaging the starter.
- D.** Release the hose clamps holding the stock carburetor in place.



- E.** Lift the subframe by removing the two lower subframe bolts. Loosen the top pivot bolt and swing the subframe up for easier carburetor access. Refer to your shop manual for your motorcycle or recreational product for torque specs when reinstalling the subframe bolts.
- F.** Loosen the cable adjustment nut at the handlebar.

# SmartCarb® Installation

## Removing the Stock Carburetor (continued)

- G.** Pull the carburetor out of the intake manifold. Remove the cap from the carburetor and pull out the slide. Remove the cable from the slide by lifting the spring first, then by pushing the cable end down and over to the release hole (depending on carburetor model), and pull it free along with the throttle return spring and cable retainer.

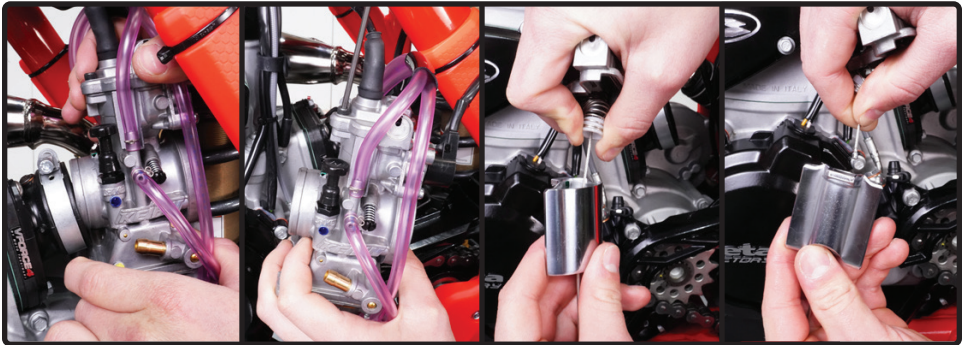

- H.** Detach the cap from the throttle cable.

### ***NOTE:***

SmartCarb® carburetors are designed for use with stock throttle assemblies and cables where applicable. If replacements of the cable(s) are necessary we recommend the use of Teflon Lined replacement cables such as the Motion Pro Slide-Light cables. We also recommend a close inspection of your throttle cables and their operation. For all disassembly of stock parts, we recommend consulting an authorized product service manual for your motorcycle, offroad or dual purpose recreational vehicle.

# SmartCarb® Installation

## SmartCarb® Inspection

### **Checking the Needle Valve**

- A. Check that the needle valve is opening and closing properly and that the it has not become stuck.

#### **NOTES:**

The needle valve within the SmartCarb® can become stuck in the closed position during shipping or if it has been sitting unused for a period of time. The needle valve must open freely to allow fuel to enter the Float Bowl.

Never perform these tests while there is fuel in the SmartCarb®. Empty and clean it first.

1. Hold the SmartCarb® upright and gently blow into the fuel inlet. Air should flow through the fuel inlet with ease, confirming that the needle valve is open.
2. Turn the SmartCarb® upside down and gently blow into the fuel inlet. Air should not flow through the fuel inlet, confirming that the needle valve is closed.

#### **NOTE:**

SmartCarb® carburetors are set at the factory with baseline settings specific to the vehicle detailed to us by the original purchaser. Do not make any adjustments to the SmartCarb® before installation. If adjustments have been made prior to or during installation, tuning the SmartCarb® may be more difficult. We recommend that you leave the SmartCarb® set at the factory settings detailed on the back of the Quick Start Guide included with your purchase for your reference.

# SmartCarb® Installation

## SmartCarb® & Slide Installation

### **1. Throttle Cable & Slide Attachment & Installation**

- A.** Remove the cap, throttle return spring, cable retainer, and slide from the SmartCarb® by removing the 4 cap screws with a 3mm Allen wrench.

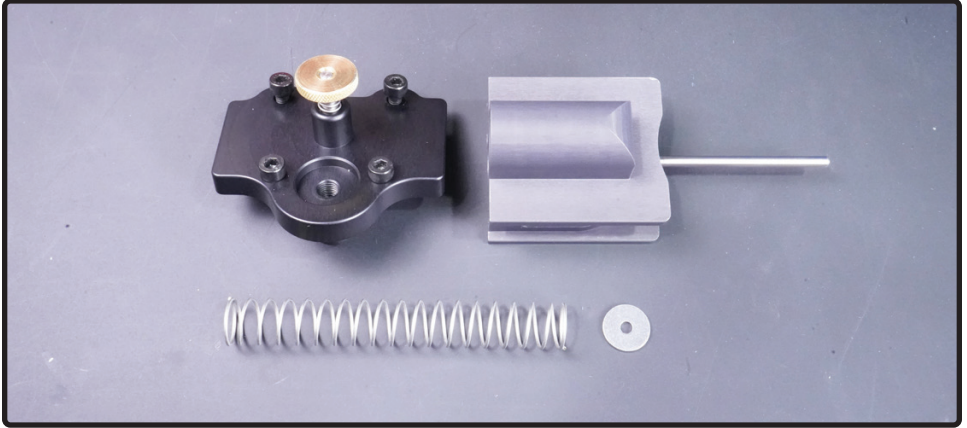

**NOTE:**

Do not bend, distort, or kink the throttle return spring. If the throttle return spring is damaged, throttle function may be compromised resulting in gritty or poor throttle feel when twisting the throttle handle.

- B.** If using a slip end cable, insert it into the top of the brass cable guide in the cap. If using a thread end cable, remove the brass cable guide (if provided with your purchase) and thread the cable directly into the cap.

**NOTE:**

SmartCarb® carburetors accept most stock throttle cable guides and thread end throttle cables using the industry standard M6x.75 thread spec.

- C.** Slide the cable through the throttle return spring, taking care not to kink or bend it while compressing it down around the nose of the cap and then insert the cable end through the retainer.



# SmartCarb® Installation

## SmartCarb® & Slide Installation (continued)

- D.** Hold the spring and cable retainer disk back and insert the cable end through the large hole in the bottom of the slide's nose.

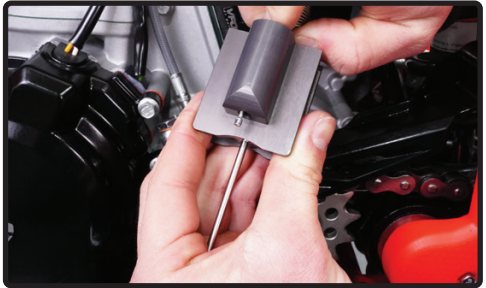

- E.** Once the cable end is through the large hole in the bottom of the slide's nose, push it over into the smaller retaining hole and carefully let the throttle return spring and cable retainer relax.

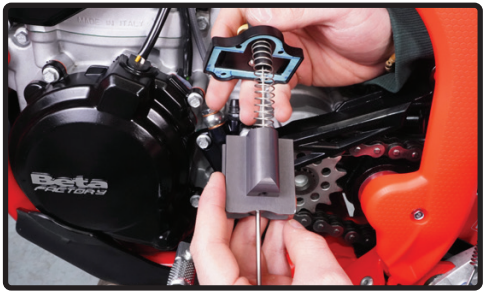

## 2. Throttle Cable Adjustments

- A.** Before installing the SmartCarb® onto the bike, insert the slide into the carburetor body, seat the cap onto the top, and tighten the 4 cap screws.

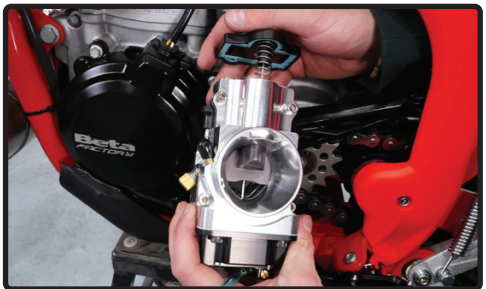

- B.** Adjust the throttle cable adjusters at the carb and at the handlebar to remove excess free play and test the throttle to be sure that it fully opens and closes freely. Turn the handlebars to extreme right and open and close the throttle, then turn the handlebars to extreme left and open and close the throttle. If the throttle binds, loosen the cable adjusters, giving the cable more free play and test again. The throttle must be able to fully open and close freely throughout the handlebar range, from right to left fork stops with minimal free play.

# SmartCarb® Installation

## SmartCarb® & Slide Installation (continued)

### **NOTES:**

The throttle cable must not bind. The slide must shut to the fully closed position when released. If the free play has been reduced all the way and the throttle cannot shut to the fully closed position from right to left fork stops, it is too short and must be replaced before operating the vehicle with the SmartCarb® installed. SmartCarb Fuel Systems recommends Motion Pro throttle cables. Please contact us for guidance on which model is correct for your vehicle.

Pay close attention to throttle cable routing. Make sure that the throttle cable is free of tight bends and pinching and that it has plenty of free play to minimize cable friction and to prevent possible throttle sticking during operation.



### **WARNINGS:**

Throttle cables must not pull tight when the handlebars are turned to the right and left fork stops. Make sure the throttle cable is clear of the fork stops at the steering head so it will not be pinched when the fork is turned against the stops.

If the throttle does not fully open and close freely, it may stick open causing a loss of control of the vehicle, resulting in possible personal injury to you and others and/or damage to the vehicle.

- C.** Tighten the throttle cable adjuster locknuts after you've successfully adjusted the cable free play.
- D.** Remove the cap and slide from the carburetor body by removing the 4 cap screws with a 3mm Allen wrench. Leave the cap, throttle return spring, cable retainer, and slide attached to the throttle cable.

# SmartCarb® Installation

## SmartCarb® & Slide Installation (continued)

### 3. SmartCarb® Installation

**NOTE:**

SC3 SmartCarb® carburetors are designed for use with spigot style manifolds.



**CAUTION:**

An improperly mounted carburetor or intake manifold could come loose from the engine, resulting in air leaks, poor performance, and conditions that could cause damage to the engine.



**WARNING:**

An improperly mounted carburetor or intake manifold could break free. If the vehicle falls and sustains damage in an accident, it could cause a dangerous release of gasoline creating a fire hazard resulting in possible personal injury to you and others and/or damage to the vehicle.

# SmartCarb® Installation

## SmartCarb® & Slide Installation (continued)

- A.** Install the SmartCarb® by inserting it into the intake manifold. Lower the subframe and guide the airboot into place.

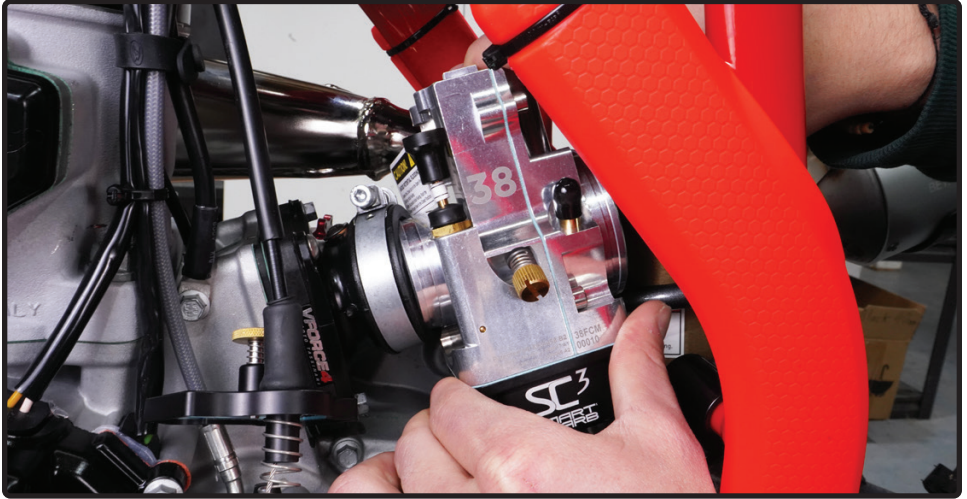

- B.** Check for pinching or distortion of the airboot. Remove the filter and look down through the airboot to ensure that the rubber is not collapsed and that the Vent Scoop located in the top of the venturi is clear and unobstructed.



**NOTE:**

If there is excessive pinching or distortion of the airboot, trimming may be required. A pinched or distorted airboot can restrict airflow into the SmartCarb®, causing poor performance, particularly if the Vent Scoop is shrouded or blocked, even partially. Visit the SmartCarb Fuel Systems YouTube channel for more specific installation guidance.

# SmartCarb® Installation

## SmartCarb® & Slide Installation (continued)



### **CAUTION:**

An excessively pinched or distorted airboot can shroud or cover the Vent Scoop in the top of the venturi, restricting airflow. Obstructing airflow into the Vent Scoop impedes SmartCarb® internal float bowl venting, potentially causing lean conditions at higher throttle positions that can cause damage to the engine.

- C.** After making sure that there is no excessive pinching or distortion of the airboot and after performing any required airboot trim, insert the slide into the carburetor body, seat the cap onto the top, and tighten the 4 cap screws.

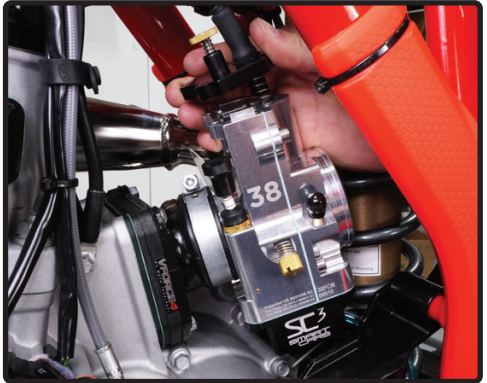

- D.** Rotate the mounted SmartCarb® to where it is as straight upright as possible and tighten the hose clamps on the intake manifold and the airboot. Make sure that the SmartCarb® is not touching any hard surface and that the Float Bowl cannot come into contact with the chain during operation of the vehicle.

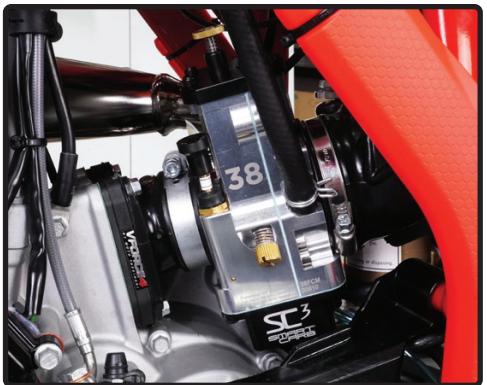

# SmartCarb® Installation

## SmartCarb® & Slide Installation (continued)



### **CAUTION:**

An improperly mounted carburetor that is touching a hard surface such as the crank or transmission case can cause fuel aeration or frothing within the Float Bowl, resulting in poor performance and potential lean conditions that could cause permanent damage to the engine.

- E.** Securely install the fuel line over the fuel inlet of the SmartCarb® using a factory clamp.
- F.** If necessary, adjust the throttle cable adjusters at the carb and at the handlebar to remove excess free play and test the throttle to be sure that it fully opens and closes freely. Turn the handlebars to extreme right and open and close the throttle, then turn the handlebars to extreme left and open and close the throttle. If the throttle binds, loosen the cable adjusters, giving the cable more free play and test again. The throttle must be able to fully open and close freely throughout the handlebar range, from right to left fork stops with minimal free play. Make sure the throttle cable adjuster locknuts are tight after final adjustment.



### **WARNING:**

Throttle cables must not pull tight when the handlebars are turned to the right and left fork stops. If the throttle does not fully open and close freely, it may stick open causing a loss of control of the vehicle, resulting in possible personal injury to you and others and/or damage to the vehicle.

# SmartCarb® Tuning Philosophy

## Tuning Introduction

The SmartCarb Fuel Systems SmartCarb® carburetor is a precision air and fuel metering instrument, capable of high-resolution adjustments for very fine tuning. When tuned properly the SmartCarb® offers substantial increases in performance, fuel economy, and run-ability. While the SmartCarb® is designed to be simple and easy to tune, a fundamental understanding of how the SmartCarb® meters air and fuel is necessary to correctly set it up and make the most of its performance potential. Read through the following sections carefully to gain a full understanding on how to tune your SmartCarb® by using the two external adjustments: the Clicker Adjuster and the Idle Set Screw.

### ***NOTE:***

We highly recommend all customers take the time to fully understand how the SmartCarb® works before beginning to tune.

## External Adjustments

### ***Clicker Adjuster***

Low speed air/fuel mixture adjustments are made externally by hand, using the high resolution Clicker Adjuster to raise or lower the metering rod independently within the slide. With the engine off simply raise the slide, depress the Clicker Adjuster, and turn right for richer and left for leaner.

### ***Idle Set Screw***

Fine low speed and idle adjustments can be made by hand to raise or lower the slide cutaway allowing for more or less airflow and precision tuning of the SmartCarb at idle.

### ***Slide***

### ***Metering Rod***

### ***Fuel Nozzle***

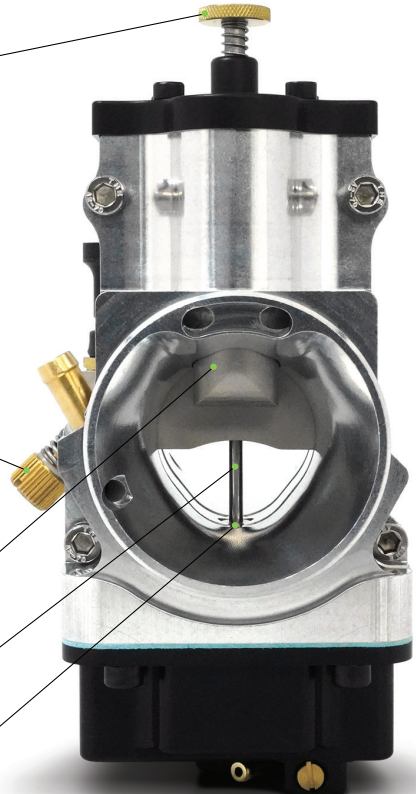

# SmartCarb® Tuning Philosophy

## 2 External Adjustments (continued)

The two external adjustments on the SmartCarb® that determine low speed air/fuel mixture values are the Clicker Adjuster on the top and the Idle Set Screw located on the side of the carburetor.

The Clicker Adjuster raises or lowers the fuel metering rod within and independent of the slide, allowing for more or less fuel to be drawn up the nozzle and past the metering rod. The Idle Set Screw raises or lowers the height of the slide cutaway, allowing for more or less air through the carburetor at idle. Proper mixture settings for the low speed are achieved when these two are balanced.

### ***NOTE:***

Small adjustments can have large impacts on tuning and performance. All adjustments should be made in **SMALL** increments when tuning your SmartCarb®.

## Clicker Adjustments

Clicker adjustments are made by opening the throttle all the way (while the engine is OFF), depressing the Clicker Adjuster down into the slide with positive contact, and then turning the clicker either left or right, clockwise or counterclockwise. Once properly engaged you will feel individual clicks (10 per single revolution of the clicker).

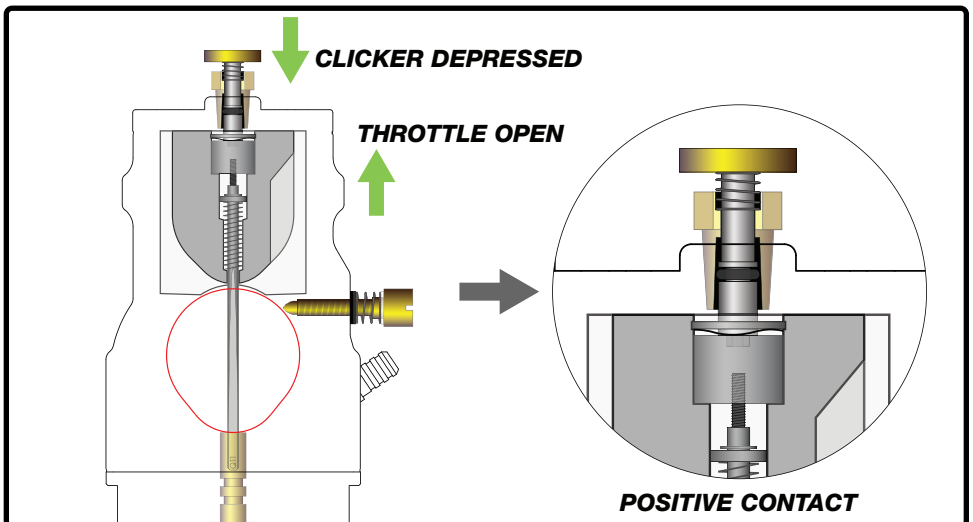



# SmartCarb<sup>®</sup> Tuning Philosophy

## Clicker Adjustments (continued)

Adjusting the Clicker Adjuster to the right, or clockwise, will raise the metering rod within the slide. Raising the metering rod will add more fuel to the mixture as it exposes more of the angled surface grind of the metering rod at the top of the nozzle near the venturi floor.

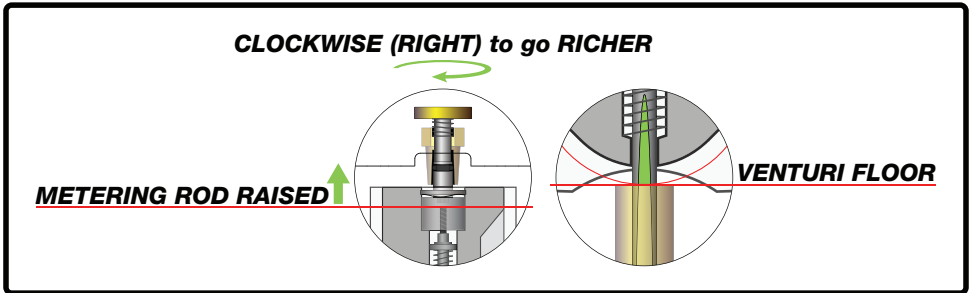

Adjusting the Clicker Adjuster to the left, or counterclockwise, will lower the metering rod within the slide. Lowering the metering rod will reduce fuel being added to the mixture as it exposes less of the angled surface grind of the metering rod.

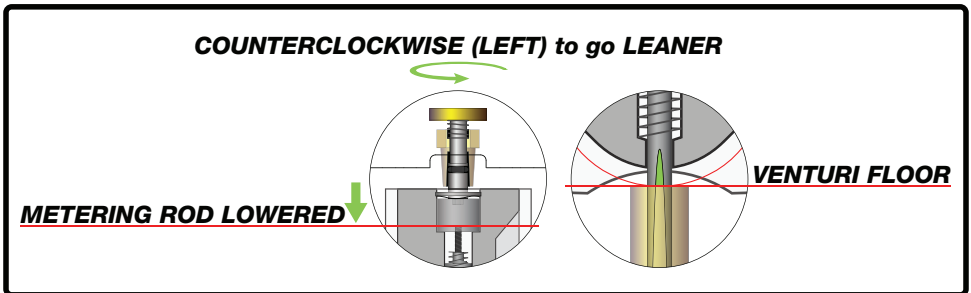

A simple rule of thumb is to turn Right for Rich (RR) and Left for Lean (LL).

### **NOTE:**

Make sure that when making adjustments you don't leave the clicker mid-way between clicks. Also be sure to assist the spring on the Clicker Adjuster plunger by manually pulling it up to the top, helping to seat the internal o-ring and preventing air leaks or mud and dirt from entering the SmartCarb<sup>®</sup> slide cavity.

# SmartCarb® Tuning Philosophy

## Clicker Adjustments (continued)

Small Idle Set Screw adjustments may be required when making changes to the Clicker Adjuster setting. Subtracting or adding fuel by adjusting the metering rod may affect idle speeds and characteristics. Richer settings will tend to make the engine idle lower, while leaner settings will make the engine idle higher. If more than slightly lean the Idle Set Screw will have little to no effect on idle speeds. If excessively lean, the engine will be difficult to start without the Choke on and will idle up and down erratically and may die off after a short period of running.

## Idle Set Screw Adjustments

Idle Set Screw adjustments are made by simply turning in or out the Idle Set Screw.

Turning the screw in clockwise to the right will raise the slide height:

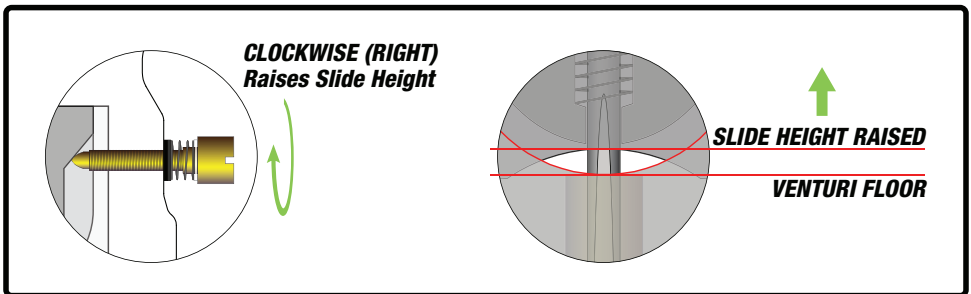

Turning the screw out counterclockwise to the left will lower the slide height:

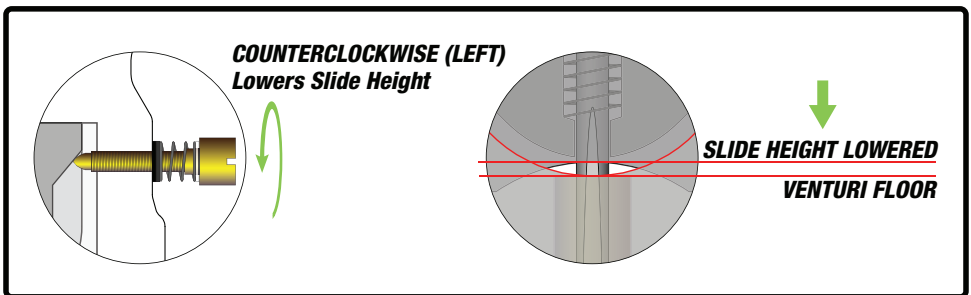

# SmartCarb® Tuning Philosophy

## Idle Set Screw Adjustments (continued)

### **NOTES:**

If turning the screw out does not lower the slide height, the slide may be hung up on the throttle cable and a throttle cable length adjustment may be necessary.

Remember to make adjustments in small increments such as quarter turns. While there is some slight variance between different engines and custom builds, a good starting point is to have the Idle Set Screw set to where the slide cutaway height is close to 2.0mm for proper idle RPMs. The 2.0mm is measured from the floor of the venturi to the top of the middle of the slide cutaway as seen below.

Your SmartCarb® comes preset from the factory. Remember that the factory Idle Set Screw setting for your SmartCarb® is located on the back of the Quick Start Guide included with your purchase for your reference.

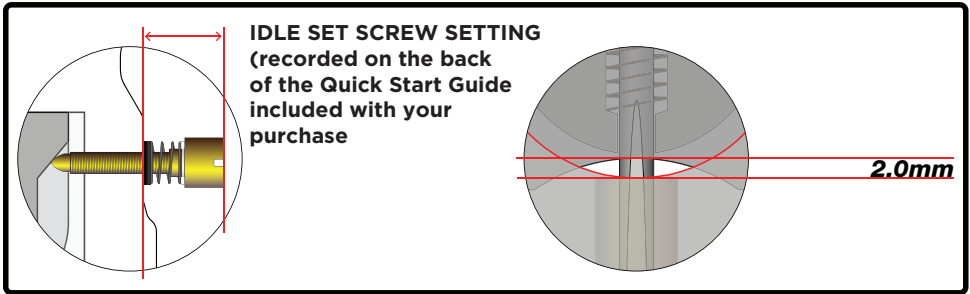

A 2.0mm slide height maximizes the signal through the venturi for high air velocity, brings the engine down smoothly back to idle when the throttle is closed, and improves cold starting by letting most of the air pass through the Choke circuit providing proper cold start enrichment and high idle warm-up.

### **NOTE:**

If the idle setting is too high, the engine will be difficult to start when cold, as a high idle setting allows incoming air to bypass the Choke circuit, cheating its ability to pull fuel into the air stream. Furthermore the high slide cutaway creates a lean condition ineffective for cold starting.

# SmartCarb® Tuning Philosophy

## Idle Set Screw Adjustments (continued)

### **NOTES:**

If the idle setting and slide cutaway are too low, the engine may stumble coming off idle and/or may bog or die when the throttle is whacked wide open quickly. You may also experience heavy pipe banging under deceleration as the excessively low slide cutaway effectively shuts off all but a very small amount of airflow to the engine when the throttle is closed. This is especially noticeable on hard decelerations after sustained wide open running.

The 2.0mm recommendation is not guaranteed to be a proper idle setting. As stated above, a slight variance of .5mm or so may be found between different engines and custom builds. The 2.0mm recommendation also only applies to SmartCarb® carburetors sized 36-40mm.

## Finding a Balance

Simply put, use the Clicker Adjuster to set the idle and low speed fuel flow FIRST and then use the Idle Set Screw to maximize signal and blend air into the idle mixture. When the two settings are close to optimum it will then be very easy to make corrections to achieve the desired idle speed. Remember that factory settings are detailed in the back of the Quick Start Guide included with your purchase. If you feel that the listed settings are incorrect or have been altered, the factory settings are recorded with us and we can provide them by phone call or email along with technical advice.

### **NOTES:**

SmartCarb Fuel Systems always recommends that new users begin tuning their SmartCarb® by FIRST dialing in their Clicker Adjuster to set the idle and low speed fuel flow before adjusting the Idle Set Screw for steady idle speed.

Difficulty narrowing down optimal settings can result when inexperienced users adjust the Clicker Adjuster settings while also making adjustments to the Idle Set Screw. Mixture settings can also affect idle RPMs.

# SmartCarb® Operation & Tuning

---

## **Tuning Preparation**

Prepare for tuning by making sure your vehicle is in good working order. Resolving any potential issues prior to tuning will ensure a smooth tuning experience.

### ***Check For Proper SmartCarb Installation***

- Check for potential air leaks by making sure that the cap screws are tight and that the intake and airboot seals and hose clamps are secure.
- Make sure the SmartCarb® is not touching any hard surface such as the crank or transmission case and that the Float Bowl cannot come into contact with the chain.
- Make sure that the throttle cable opens and closes freely throughout the entire handlebar range (from right fork stop to left fork stop), that it is free of tight bends and pinching, and that it has plenty of free play to minimize cable friction and to prevent possible throttle sticking during operation.
- Be sure that the airboot is not excessively pinched or distorted and that it is not shrouding the Vent Scoop located in the top of the venturi.

### ***Check the Spark Plug***

Take a look at your spark plug prior to tuning your SmartCarb®. Note the condition and coloration. If the plug is worn out or has been fouled recently, replace it with a new plug. If you begin tuning with a new spark plug it will take some running time before you will be able to see accurate color readings.

# SmartCarb® Operation & Tuning

## Tuning Preparation (continued)

### **NOTES:**

SmartCarb® carburetors are set at the factory with baseline settings specific to the vehicle detailed to us by the original purchaser. Do not make any adjustments to the SmartCarb® until doing the Idle Performance Assessment. If adjustments have been made prior to or during installation, tuning the SmartCarb® may be more difficult. We recommend that you leave the SmartCarb® set at the factory settings and that you follow all tuning steps, in order, for successful tuning of the SmartCarb®.

The factory settings for your SmartCarb® are located on the back of the Quick Start Guide included with your purchase. If the settings are lost or rendered illegible, customers can contact us for their particular factory settings. We recommend that customers keep this manual for reference and use the Tuning Notes section in the back to record adjustments made during tuning.



### **WARNINGS:**

A moderate level of tuning skill is recommended, though not required, to tune the SmartCarb®. After carefully reading these instructions, if you have any doubts, we recommend that you contact us or have a professional tune the SmartCarb® for you.

Never operate or run an engine in an enclosed space. Perform all tuning steps in a well ventilated area. Failure to do so can result in possible personal injury to you and others.

When riding the vehicle SmartCarb Fuel Systems recommends that customers wear all appropriate safety gear to avoid personal injury.

# SmartCarb® Operation & Tuning

## Starting Procedures

### **1. Cold Starting**



#### **WARNINGS:**

When the vehicle is not running or in use, the fuel valve (petcock) should always be turned to the OFF position to prevent potential fuel leakage past the SmartCarb® carburetor's needle valve, particularly during storage or when the vehicle is being moved (i.e. on a trailer or in the bed of a truck).

The Choke must be opened when filling the Float Bowl from empty with fuel (i.e. the first filling or if it has been drained) in order for the air in the Float Bowl to escape. Failure to open the Choke when filling from empty can result in fuel short circuiting up the nozzle and potentially flooding the engine.

Fuel leakage past the needle valve may flood the engine, causing a fire hazard and possible personal injury to you and others and/or damage to the vehicle.

- A.** Open the Choke, especially if the Float Bowl is empty.
- B.** Slowly open the fuel valve (petcock) to add fuel to the SmartCarb®.
- C.** Turn on the ignition and engage the starter to start the engine.

#### **NOTES:**

Do not open or roll the throttle when cold starting the engine while the Choke is open. Doing so impedes the Choke circuit's operation.

You may find that using the Choke during cold starting is unnecessary if the SmartCarb® carburetor's settings are ideal, however the Choke must be opened when filling the Float Bowl from empty (i.e. the first filling or if it has been drained).

- D.** Push the Choke into the closed position after the engine has started and warmed to proper operating temperature.

# SmartCarb<sup>®</sup> Operation & Tuning

## Starting Procedures (continued)

### **2. Hot Starting**

- A.** Make sure that the fuel valve (petcock) is in the open position.
- B.** Turn on the ignition and engage the starter to start the engine.

**NOTE:**

If the engine fails to hot start, open or roll the throttle slightly while engaging the starter until the engine fires.



# SmartCarb® Operation & Tuning

## Tuning Idle Quality

### **1. Starting the Engine**

#### **NOTES:**

Refer to Page 31 for proper starting procedures.

Do not make any adjustments to the SmartCarb® until doing the Idle Performance Assessment.

**A.** Open the Choke and start the engine. If the engine does not start, follow the procedures below. If the engine starts, proceed to step **B.** on Page 37.

- 1.** Assess the SmartCarb® for flooding or fueling issues. If you smell fuel or otherwise determine that flooding is occurring, immediately turn the fuel valve (petcock) to the OFF position.



#### **WARNINGS:**

Flooding is indicative of either a stuck or compromised needle valve within the SmartCarb® or short circuiting of fuel up the nozzle. If flooding occurs, immediately turn the fuel valve (petcock) to the OFF position. We recommend that you use the applicable shop manual for your motorcycle or recreational product for reference on safely drying out a flooded engine.

Fuel leakage past the SmartCarb® carburetor's needle valve or short circuiting of fuel up the nozzle may flood the engine, causing a fire hazard and possible personal injury to you and others and/or damage to the vehicle.

# SmartCarb® Operation & Tuning

## Tuning Idle Quality (continued)

- a.** Turn the fuel valve (petcock) to the OFF position.
- b.** Hold the drain hose up and against the leading (engine side) edge of the flange of the Float Bowl (closest to the intake manifold, furthest from the airboot). Pull the hose as high as you can without kinking it. Do not move the hose while performing this procedure.
- c.** Using a 1/4" flat head screwdriver, slowly open the drain screw at the bottom of the Float Bowl.
- d.** Watch the drain hose closely, monitoring the fuel level as it rises.
  - If the SmartCarb® carburetor's floats are operating correctly, the fuel level in the drain hose should stop rising 8-10 millimeters above the Float Bowl gasket. Close the drain screw, empty the drain hose, and proceed to step **2.** on Page 36 to assess the vehicle.
  - If the fuel level stops well below the 8-10mm reference above the Float Bowl gasket, the SmartCarb® may have been short circuiting fuel up the nozzle. If you suspect flooding has occurred, close the drain screw, empty the drain hose, and gently tap on the side of the SmartCarb®. Refer to your applicable shop manual for reference on safely drying out a flooded engine before proceeding. Then repeat steps **A.** and **B.** of the cold starting procedures on Page 31 to properly add fuel to the SmartCarb® before attempting to start the engine.



### **WARNINGS:**

Never attempt to start a flooded engine. Always refer to your applicable shop manual for reference on safely drying out a flooded engine.

Attempting to start a flooded engine can cause a fire or explosion hazard leading to possible personal injury to you and others and/or damage to the vehicle.

# SmartCarb® Operation & Tuning

## Tuning Idle Quality (continued)

- If the fuel level continues to rise well above the 8-10mm reference above the Float Bowl gasket and/or begins spilling out of the drain hose, immediately close the drain screw and turn the fuel valve (petcock) to the OFF position. Then empty the drain hose. The needle valve within the SmartCarb® may be stuck or otherwise compromised. It is likely that the engine has been flooded. Refer to your applicable shop manual for reference on safely drying out a flooded engine before proceeding. After the engine has been cleared, make sure the fuel valve (petcock) at the tank is turned OFF and then completely drain the SmartCarb® prior to uninstalling it from the vehicle. Refer to Page 55 for SmartCarb® cleaning instructions which show how to access a stuck or compromised needle valve. Do not proceed with SmartCarb® tuning until the needle valve has been cleared and determined to be in proper working order.



### **WARNING:**

Gasoline is extremely flammable and highly explosive. It can also be very harmful if inhaled. Perform installation, tuning, and troubleshooting in a well ventilated area. Keep open flame or sparks away from gasoline at all times.

# SmartCarb<sup>®</sup> Operation & Tuning

## Tuning Idle Quality (continued)

- If no fuel enters the drain hose then the SmartCarb<sup>®</sup> may not be getting fuel. The needle valve may be stuck in the closed position. Close the drain screw and turn the fuel valve (petcock) to the OFF position. Confirm that there is fuel in the tank, that the tank is venting properly, and that the fuel valve (petcock) is flowing properly to allow fuel to enter the SmartCarb<sup>®</sup>. If using clear fuel line, check to see if there is fuel in it. Gently tap on the side of the SmartCarb<sup>®</sup> and repeat steps **A.** and **B.** of the cold starting procedures on Page 31 to properly add fuel to the SmartCarb<sup>®</sup> before attempting to start the engine. If the SmartCarb<sup>®</sup> will still not fill, make sure the fuel valve (petcock) at the tank is turned OFF prior to uninstalling it from the vehicle. Refer to Page 55 for SmartCarb<sup>®</sup> cleaning instructions which show how to access a stuck or compromised needle valve. Do not proceed with SmartCarb<sup>®</sup> tuning until the needle valve has been checked and determined to be in proper working order.
- 2.** Assess the vehicle for problems with starting. We recommend that you also use the applicable shop manual for your motorcycle or recreational product for reference.
- a.** Check the spark plug to see if it is wet or dry. A wet plug means the engine is getting fuel. A dry plug means it is not.
  - b.** After making sure that the engine is not flooded and is clear of fuel, check the spark plug for spark by holding it against a head bolt and engaging the starter to see if there is any spark.



**WARNING:**

Gasoline is extremely flammable and highly explosive. Keep open flame, sparks, or any other source of ignition away from gasoline at all times.

# SmartCarb® Operation & Tuning

## Tuning Idle Quality (continued)

- B.** Leave the Choke open and let the engine warm up. Once the idle begins to drop and the engine has reached operating temperatures, close the Choke.

### **2. Assessing Idle Performance**

#### **NOTES:**

SmartCarb® carburetors are set at the factory with baseline settings specific to the vehicle detailed to us by the original purchaser. If the SmartCarb® is being used on a different vehicle than the one specified when ordered, please contact us and we can provide you with baseline settings and application-specific advice.

As mentioned in the SmartCarb® Tuning Philosophy section, we always recommend that tuners begin tuning their SmartCarb® by first dialing in their Clicker Adjuster to set the idle and low speed fuel flow before adjusting the Idle Set Screw for steady idle speed. As set from the factory, the Idle Set Screw setting (on the back of the Quick Start Guide included with your purchase) gives a slide cutaway height of 2.0mm. Simply stated, the slide cutaway height is the air metering portion of the air/fuel metering equation at idle. Since air metering is very close to ideal at idle, it is the fuel metering that must be adjusted first to bring the equation into an ideal balance or ratio for the engine's needs. Only then should the Idle Set Screw be used for very fine idle adjustments.

Some breaking-in occurs with new SmartCarb® carburetors. We recommend that users refrain from making large changes in their settings (unless otherwise required) until the breaking-in has been completed. Breaking-in may take a few hours of riding.

- A.** Listen to and analyze the idle quality for signs of rich or lean conditions. The goal is to achieve a strong, steady idle.
- 1.** Lean conditions at idle symptoms include:
- High erratic idle
  - Opening the Choke improves and lowers the idle speed
  - The engine dies after a short amount of time

#### **NOTE:**

A lean condition at idle may be due to an air leak. Check for potential air leaks by making sure that the cap screws are tight and that the intake and airboot hose clamps and seals are secure.

# SmartCarb® Operation & Tuning

## Tuning Idle Quality (continued)

2. Rich conditions at idle symptoms include:
  - Smoky exhaust (may be due to a prior flooding incident)
  - Opening the Choke does not improve idle quality
  - Engine idling too low/dying
3. Ideal conditions at idle symptoms include:
  - Strong, steady idle
  - Little to no visible smoke from the exhaust
  - Minimal loss of RPMs when shifting the vehicle into gear



### **WARNING:**

Do not shift into gear unless you are in full control of the vehicle. Shifting into gear may cause the vehicle to lurch forward, leading to possible personal injury to you and others and/or damage to the vehicle.

- B.** Before making any Clicker adjustments, open the throttle open a few times and analyze the return to idle for signs of lean or rich conditions.

1. Lean conditions after opening the throttle symptoms:
  - A noticeable bog and lack of power
  - A hanging return to idle (engine doesn't want to idle down quickly)
2. Rich conditions after opening the throttle symptoms:
  - A stumble at first before cleaning out and revving up
  - Exhaust emitting lots of smoke
3. Ideal conditions when opening the throttle symptoms:
  - A quick return to a strong, steady idle
  - Smooth, linear tip-in and quick throttle response
  - Little to no visible smoke from the exhaust

### **NOTE:**

Throttle response is best assessed while in gear, riding - not on the stand or in neutral.

# SmartCarb® Operation & Tuning

## Tuning Idle Quality (continued)

### **3. Adjusting for Proper Idle Performance**

- A. Turn the engine OFF prior to making any Clicker adjustments.



#### **WARNING:**

Never attempt to make Clicker Adjuster adjustments while the engine is running. Using the Clicker Adjuster requires that the slide be in the fully opened position and the Clicker plunger to be depressed into the body cavity which when combined can cause a wide-open, dangerous, lean condition that can cause damage to the engine if it is running and personal injury to you or others.

- B. Based on the results of the idle performance assessment, make any necessary adjustments to the idle and low speed fuel flow using the Clicker Adjuster on the top of the SmartCarb®. Refer to Page 24 for instructions on how to perform Clicker adjustments.

#### **NOTES:**

Small adjustments can have large impacts on tuning and performance. All adjustments should be made in SMALL increments when tuning your SmartCarb®.

Make sure that when making adjustments you don't leave the clicker mid-way between clicks. Also be sure to assist the spring on the Clicker Adjuster plunger by manually pulling it up to the top, helping to seat the internal o-ring and preventing air leaks or mud and dirt from entering the SmartCarb® slide cavity.

## Tuning Idle Quality (continued)

1. If a lean condition was assessed when analyzing idle quality, use the Clicker Adjuster to turn the Clicker one (1) or two (2) clicks to the right or clockwise to raise the metering rod within the slide and increase fuel flow up the nozzle. Repeat if necessary.
2. If a rich condition was assessed when analyzing idle quality, use the Clicker Adjuster to turn the Clicker one (1) or two (2) clicks to the left or counterclockwise to lower the metering rod within the slide and reduce fuel flow up the nozzle. Repeat if necessary.

### **NOTES:**

As a rule, only make small adjustments of one (1) or two (2) clicks at a time unless the assessed lean or rich condition is severe. In such cases, making larger adjustments with more clicks at a time is acceptable. However if a large adjustment makes the lean or rich condition worse, you're likely going in the wrong direction. Return to the original factory clicker setting (shown on the back of the Quick Start Guide included with your purchase) and start again.

To return to factory clicker settings, click the clicker all the way to the right or clockwise until it stops and then click the clicker to the left or counterclockwise and count the clicks until you arrive at the factory number of clicks. The factory clicker setting number is the number of clicks to the left (counterclockwise) from the full rich position.

When the Clicker Adjuster setting is close to being ideal you will notice that small changes will have large impacts on idle and low speed running characteristics. If Clicker adjustments do not change idle or running characteristics, then a severe lean or rich condition still exists and further work is needed with the Clicker Adjuster to find an optimal setting. Always be aware of potential air leaks.

- C. Hot start the engine and repeat step 2. **Assessing Idle Performance** on Page 37 and make Clicker adjustments until ideal idle performance have been achieved. Make sure the engine is OFF when making Clicker adjustments.
- D. Make any necessary adjustments to the Idle Set Screw while the engine is running to fine tune idle quality.



# SmartCarb® Operation & Tuning

## Tuning Idle Quality (continued)

### **NOTES:**

Changes to the Clicker Adjuster setting by adding or reducing fuel flow up the nozzle can affect idle quality. For instance, adding fuel to the mixture will cause the engine to idle lower. Conversely, reducing fuel from the mixture will cause the engine to idle higher.

SmartCarb Fuel Systems always recommends that new users begin tuning their SmartCarb® by first dialing in their Clicker Adjuster to set the idle and low speed fuel flow before adjusting the Idle Set Screw for steady idle speed.

Remember that there is some breaking-in that occurs with new SmartCarb® carburetors and we recommend that users refrain from making large changes in their settings (unless otherwise required) until the breaking-in has been completed. Breaking-in may take a few hours of riding.

## Tuning Low Speed

### **1. Assessing Low Speed Performance**

- A.** Start the engine and let it warm to operating temperatures. Refer to Page 31 for proper starting procedures.
- B.** Ride the vehicle in a safe area from low to medium throttle openings and analyze idle and low speed performance for lean or rich conditions.



#### **WARNINGS:**

Never operate or run an engine in an enclosed space. Perform all tuning steps in a well ventilated area. Failure to do so can result in possible personal injury to you and others.

When riding the vehicle SmartCarb Fuel Systems recommends that customers wear all appropriate safety gear to avoid personal injury.

- 1.** Lean condition indicators when riding at low to medium throttle openings include:
  - Engine bogs when the throttle is opened quickly
  - Engine feels weak and there's a noticeable lack of power
  - Engine stumbles and dies
- 2.** Rich condition indicators when riding at low to medium throttle openings include:
  - Engine feels blubbery or burbly when the throttle is opened
  - Exhaust emitting lots of smoke
  - Lazy vehicle acceleration
- 3.** Ideal condition indicators when riding at low to medium throttle openings include:
  - Clean, smooth vehicle acceleration
  - Strong, linear throttle response
  - No engine stalling at low speeds/low throttle openings

## Tuning Low Speed (continued)

### **2. Adjusting For Proper Low Speed Performance**

- A.** Based on the results of the low speed performance assessment, make any necessary adjustments to the idle and low speed fuel flow using the Clicker Adjuster on the top of the SmartCarb® and the Idle Set Screw on the side. Refer to Page 24 for instructions on how to perform Clicker adjustments and Page 26 for instructions on how to perform Idle Set Screw adjustments. Make sure the engine is turned OFF before making any Clicker adjustments.
- 1.** If a lean condition was assessed when analyzing low to medium throttle openings, use the Clicker Adjuster to turn the Clicker one (1) or two (2) clicks to the right or clockwise to raise the metering rod within the slide and increase fuel flow up the nozzle. Repeat if necessary.
  - 2.** If a rich condition was assessed when analyzing low to medium throttle openings, use the Clicker Adjuster to turn the Clicker one (1) or two (2) clicks to the left or counterclockwise to lower the metering rod within the slide and reduce fuel flow up the nozzle. Repeat if necessary.

#### **NOTE:**

Changes to the Clicker Adjuster setting by adding or reducing fuel flow up the nozzle can affect idle quality. For instance, adding fuel to the mixture will cause the engine to idle lower. Conversely, reducing fuel from the mixture will cause the engine to idle higher. Small Idle Set Screw Adjustments may be necessary to maintain a strong, steady idle.



#### **WARNING:**

Never attempt to make Clicker Adjuster adjustments while the engine is running. Doing so can cause permanent damage to the engine and personal injury to you or others.

# SmartCarb® Operation & Tuning

## Tuning Low Speed (continued)

- B.** Repeat step **1. Assessing Low Speed Performance** on Page 42 and make Clicker and Idle Set Screw adjustments until ideal idle and low speed performance has been achieved.

## Tuning Top End

### **1. Assessing Top End Performance**

#### **NOTES:**

Unlike idle and low speed fuel flow, top end fuel flow is controlled by the grind angle of the metering rod and proper internal Float Bowl venting through the Vent Scoop located in the top of the venturi. The metering rod grind angle determines the metering rod tip thickness. A thicker tip thickness reduces fuel flow on the top end. A thinner tip thickness increases fuel flow on the top end. SmartCarb® carburetors are set at the factory with the correct metering rod specific to the application characteristics detailed to us by the original purchaser.

The original metering rod that was sent with the SmartCarb® when it was purchased new is specified on the back of the Quick Start Guide included with the original purchase. The metering rod designation is also etched onto the bottom end of the metering rod for reference.

Adjusting the top end fuel flow requires a metering rod change. The steps to change a metering rod are explained on Page 48. Please contact us over the phone or via email for a list of available metering rods and we can assist you in choosing the correct metering rod for your specific vehicle set up.

- A.** Start the engine and let it warm to operating temperatures. Refer to Page 31 for proper starting procedures.
- B.** Ride the vehicle in a safe area with a straight, smooth straightaway with good visibility where you can hold the throttle wide open for a short distance and analyze top end performance for lean or rich conditions.

## Tuning Top End (continued)



### **CAUTION:**

Running an engine at the top end or wide open with a severe lean condition can cause damage to the engine. Stop immediately if a lean condition is indicated and make necessary adjustments to increase top end fuel flow to alleviate the lean condition.



### **WARNING:**

When riding the vehicle SmartCarb Fuel Systems, Inc recommends that customers wear all appropriate safety gear to avoid personal injury.

- 1.** Lean condition indicators when riding at medium to wide open throttle openings include:
  - Engine feels sluggish and hollow sounding
  - Engine feels weak and there is a noticeable lack of power
  - Engine RPMs hang while returning to idle on decel
- 2.** Rich condition indicators when riding at medium to wide open throttle openings include:
  - Engine speeds pick up slightly when throttle is let off
  - Exhaust emitting lots of smoke
  - Lazy vehicle acceleration
- 3.** Ideal condition indicators when riding at medium to wide open throttle openings include:
  - Clean, smooth vehicle acceleration
  - Strong, linear throttle response
  - Engine feels powerful and clean

## Tuning Top End (continued)

- C.** Examine your spark plug for lean or rich indicators.

### **NOTES:**

Refer to your applicable shop manual for your motorcycle or recreational product for steps on how to properly extract the spark plug.

If you began tuning with a new spark plug it will take some running time before you will be able to see accurate color readings.

Never let the vehicle idle for a long period of time before checking the spark plug. The color readings will not be accurate if you do.

- 1.** Lean condition indicators on the spark plugs when riding at medium to wide open throttle openings include:
  - Chalky, white looking plug with whisker-like protrusions
  - The electrode burn has spread beyond the bend in the electrode
- 2.** Rich condition indicators on the spark plugs when riding at medium to wide open throttle openings include:
  - Black, sooty, or oily plug
  - Plug threads are wet
  - The electrode burn has not reached the bend in the electrode
- 3.** Ideal condition indicators on the spark plugs when riding at medium to wide open throttle openings include:
  - Mocha, or tan colored plug
  - The electrode burn has reached to the middle of the bend in the electrode

## ***2. Adjusting For Proper Top End Performance***

- A.** By now you have dialed in the idle and low speed Clicker Adjuster and Idle Set Screw settings for optimal performance at idle and through low to medium throttle openings. Based on the results of the top end performance assessment, a metering rod change may be necessary. Instructions on changing a metering rod are explained on Page 48.

## Tuning Top End (continued)

### ***NOTE:***

Make sure that the Vent Scoop located in the top of the venturi is not blocked or obstructed by a rubber ridge or lip inside of the airboot. Remove the air filter and look down through the airboot to confirm. If the Vent Scoop is blocked or obstructed, top end fuel flow may be negatively affected causing a potential lean condition. Trim the airboot if necessary to remove Vent Scoop obstruction.

1. If a lean condition was assessed when analyzing top end performance, install a richer metering rod.
2. If a rich condition was assessed when analyzing top end performance, install a leaner metering rod.

### ***NOTES:***

Metering rods are designated with letters and numbers in this format: X-X##. The numbers represent the grind angle of the metering rod. The higher the number, the leaner the metering rod. Conversely, the lower the number, the richer the metering rod. For example, a common metering used in 36-40mm SC3 SmartCarb® carburetors is the A-Q09. A leaner metering rod would be an A-Q11. A richer metering rod would be an A-Q07.

If a metering rod change is necessary, write down your settings in the Tuning Notes section in the back of this manual before you change the metering rod. It is likely that your idle and low speed settings were ideal and a metering rod change will not greatly affect the idle and low speed qualities. When the new metering rod is installed, simply set the number of clicks to your recorded number and begin tuning from there.

- B.** Briefly revisit the Tuning Idle Quality and Tuning Low Speed sections of this manual before Assessing Top End Performance (Page 44). Make any metering rod changes necessary until ideal top end performance has been achieved.

# Changing the Metering Rod

## Metering Rod Removal and Replacement

### **1. Removing a Metering Rod**

- A.** Loosen the hose clamps on the intake manifold and the airboot. Rotate the SmartCarb® toward you for easier access to the cap.
- B.** Open the throttle all the way (while the engine is OFF), depress the Clicker Adjuster down into the slide with positive contact, and begin counting the clicks with the Clicker Adjuster to the right or clockwise until it is in the full rich position. Write the number of clicks down in the Tuning Notes section at the end of this manual for your reference. You will likely be setting the replacement metering rod to this setting.



#### **CAUTION:**

When clicking the Clicker Adjuster to the right or clockwise to the full rich position, do not over-tighten the clicker or use excessive force. Clicking beyond the full rich position may damage the metering rod.

- C.** Remove the cap, throttle return spring, cable retainer, and slide from the SmartCarb® by removing the 4 cap screws with a 3mm Allen wrench.
- D.** Remove the slide from the cable. Gently compress the throttle return spring to push the cable end out the bottom of the slide's nose. Push it over into the larger hole in the slide's nose and relax the spring. The slide should be free of the cable.

#### **NOTE:**

Do not bend, distort, or kink the throttle return spring. If the throttle return spring is damaged, throttle function may be compromised resulting in gritty or poor throttle feel when twisting the throttle handle.



# Changing the Metering Rod

## Metering Rod Removal and Replacement (continued)

- E.** While holding the slide over a workbench or table, remove the “C” clip or internal snap ring and the wave washer.

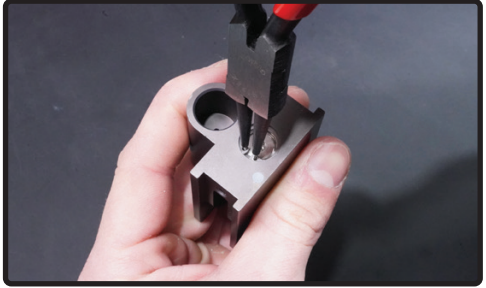

**NOTE:**

Do not damage or lose the metering rod spring located beneath the metering rod.

- F.** Remove the adjuster assembly and metering rod from the slide.

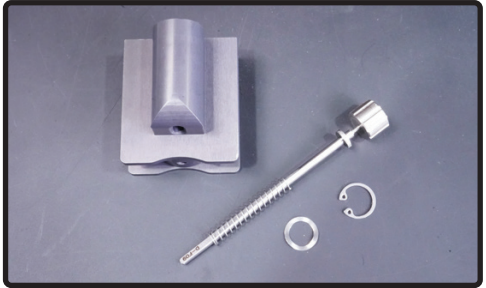

- G.** Unscrew the adjuster or clicker barrel from the metering rod.



# Changing the Metering Rod

## Metering Rod Removal and Replacement (continued)

### **2. Installing a Metering Rod**

- A.** Screw the adjuster or clicker barrel all the way down onto the replacement metering rod with the female hex feature on top. Do not over-tighten the adjuster onto the metering rod.
- B.** Slide the metering rod spring up onto the metering rod underneath the D-Washer and insert the assembly and metering rod into the slide. Push the assembly all the way down into the slide and hold it in the lowered position by holding the metering rod protruding from the bottom of the slide. The metering rod must be rotated with the flat grind indexed toward the back or flat of the slide. It can only go in one way.
- C.** Place the wave washer on top of the adjuster and then install the “C” clip or internal snap ring into its groove. Make sure the wave washer is centered underneath the “C” clip or internal snap ring.
- D.** Reattach the slide to the throttle cable. For steps on how to install the slide to the throttle cable, refer to steps **C.** through **F.** on Page 16.
- E.** Insert the slide into the carburetor body, seat the cap onto the top, and tighten the 4 cap screws.
- F.** Open the throttle all the way, depress the Clicker Adjuster down into the slide with positive contact, and click the adjuster to the left or counterclockwise until you have returned to the clicker count from full rich that you wrote down in the Tuning Notes section of this manual. If you did not write down your clicks from full rich before, set the clicker count from full rich to the factory number detailed on the back of the Quick Start Guide included with your purchase.
- G.** Rotate the SmartCarb® to where it is as straight upright as possible and tighten the hose clamps on the intake manifold and the airboot. Make sure that the SmartCarb® is not touching any hard surface and that the Float Bowl cannot come into contact with the chain during operation of the vehicle.
- H.** Re-assess idle, low speed, and top end performance. Steps are detailed starting on Page 29.

#### **NOTES:**

After step **C.** you may choose to adjust the clicker to the desired number of clicks before installing the slide into the SmartCarb by using a 3mm allen wrench. If you do, skip step **F.**

Up-to-date SmartCarb tuning baselines including clicker settings are available at [smartcarb.com/technical-support](http://smartcarb.com/technical-support)

# Checking/Adjusting Float Level

## Checking the Float Level

### **1. Checking Float Control While the SmartCarb® Is Mounted**

#### **NOTE:**

A SmartCarb® in one vehicle may be more or less angled or “tilted” than a SmartCarb® in another. Checking the fuel level while the SmartCarb® is mounted will only provide ballpark or relative measurements. SmartCarb Fuel Systems recommends that users remove the Float Bowl and follow steps **G.** through **J.** on Page 53 for more accurate float setting measurements and adjustments, if necessary.



#### **WARNING:**

Leave the fuel valve (petcock) turned to the ON position for the duration of checking the float level while the SmartCarb® is mounted. The floats will close the needle valve once the Float Bowl has filled. If flooding occurs, immediately turn the fuel valve to the OFF position. Fuel leakage past the needle valve may flood, causing a fire hazard.

- A.** Hold the drain hose up and against the leading (engine side) edge of the flange of the Float Bowl. Do not kink or move the hose while performing this procedure.
- B.** Using a 1/4” flat head screwdriver, slowly open the Float Bowl drain screw.
- C.** Watch the drain hose closely, monitoring the fuel level as it rises.
  
- D.** When the floats are set properly, the fuel level in the drain hose should stop rising 8-10 millimeters above the Float Bowl gasket.



# Checking/Adjusting Float Level

## Checking the Float Level (continued)



### ***WARNING:***

If the fuel continues to rise or begins spilling out of the drain hose, immediately close the drain screw and shut the fuel valve (petcock) to the OFF position. Flooding is indicative of either a stuck or compromised needle valve within the SmartCarb® or short circuiting of fuel up the nozzle. Refer to your applicable shop manual for reference on safely drying out a flooded engine before proceeding. After the engine has been cleared, make sure the fuel valve (petcock) at the tank is turned OFF and then completely drain the SmartCarb® prior to uninstalling it from the vehicle. Refer to Page 55 for SmartCarb® cleaning instructions which show how to access a stuck or compromised needle valve.

- E.** Close the drain screw tight and then empty the drain hose of fuel.
- F.** If float adjustments are needed, follow the steps below in **2. Making Float Level Adjustments**.

## **2. Making Float Level Adjustments**

### ***NOTE:***

Making float level adjustments requires the removal of the SmartCarb® from the vehicle in order to remove the Float Bowl.

- A.** Make sure the fuel valve (petcock) at the tank is turned OFF and then completely drain the SmartCarb® of fuel prior to uninstalling it from the vehicle.
- B.** Loosen the hose clamps on the intake manifold and the airboot. Rotate the SmartCarb® toward you for easier access to the cap.
- C.** Make sure the fuel valve (petcock) is turned to the OFF position and remove the fuel line from the fuel inlet on the SmartCarb®.
- D.** Remove the cap, throttle return spring, cable retainer, and slide from the SmartCarb® by removing the four (4) cap screws with a 3mm Allen wrench.

# Checking/Adjusting Float Level

## Adjusting the Float Level

- E.** Remove the hose clamps and then remove the SmartCarb® from the intake manifold and airboot by pulling it toward or into the airboot and twisting it to the side and out. Keep the SmartCarb® upright to avoid spilling any fuel out of the fuel inlet.
  
- F.** While holding the SmartCarb® upright, remove the four (4) Float Bowl socket head screws using a 4mm Allen wrench.



### **WARNING:**

Gasoline is extremely flammable and highly explosive. It can also be very harmful if inhaled. Perform these procedures in a well ventilated area. Keep open flame or sparks away from gasoline at all times.

- G.** Assess the POM float setting by tilting the SmartCarb® so that the float tab barely contacts or rests on the float needle valve plunger (about 60 degrees). Viewing from the choke side of the SmartCarb®, watch where the POM float parting line points along the brass choke pick-up tube.

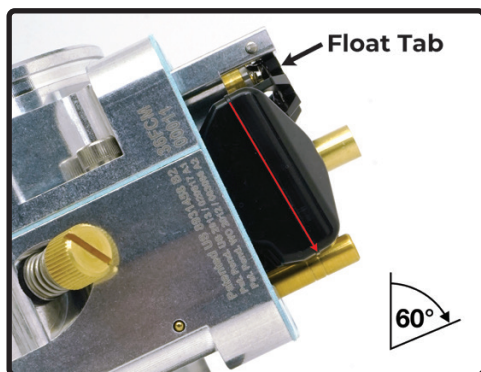

# Checking/Adjusting Float Level

## Adjusting the Float Level (continued)

- H.** The two machine marks on the choke pick-up tube define the acceptable float adjustment range. Make any necessary adjustments by performing step **J.** below.

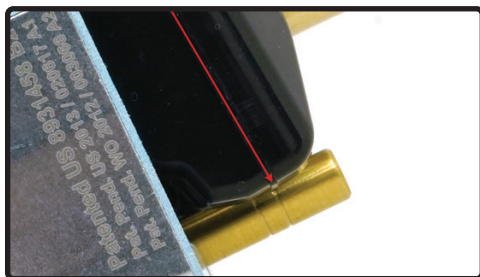

- J.** Raise or lower the float level setting by making small adjustments to the small tab located in the POM float that rides on the needle valve plunger.
- To raise the float level, carefully bend the tab up.
  - To lower the float level, carefully bend the tab down.
- Reassess float level by repeating step **G.**

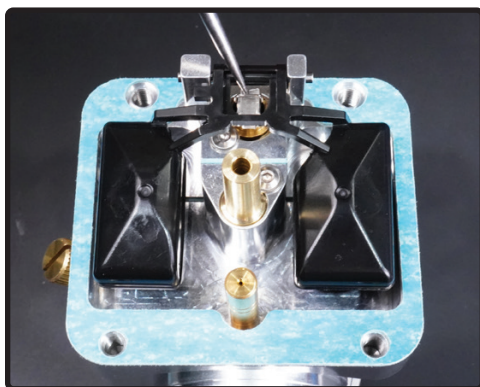

### **NOTES:**

Make small adjustments when bending the small tab on the POM float. SmartCarb Fuel Systems recommends that adjustments to the tab are made in .5 millimeter increments or less at a time.

It is assumed that the SmartCarb® will be positioned up-side-down while adjustments are being made. When considering “up” and “down” as mentioned above, disregard the fact that the SmartCarb® is up-side-down and take “up” to mean toward the ceiling and take “down” to mean toward the floor.

- K.** Perform step **F.** in reverse order to reattach the Float Bowl to the SmartCarb®.
- L.** Reinstall the SmartCarb® to the vehicle following step **3. SmartCarb® Installation** on Page 19.

# SmartCarb<sup>®</sup> Maintenance

## SmartCarb<sup>®</sup> Cleaning & Maintenance

### 1. Cleaning the SmartCarb<sup>®</sup>

#### **NOTE:**

When cleaning the SmartCarb<sup>®</sup> carburetor, take care not to lose any pieces during disassembly. Be gentle when handling the internal components. It is a precision instrument and some internal components can be easily damaged if dropped or mishandled.

- A.** Follow step **2. Checking the Float Level and Making Float Level Adjustments** on Page 52 to remove the cap, throttle return spring, cable retainer, and slide from the SmartCarb<sup>®</sup>, remove the SmartCarb<sup>®</sup> from the vehicle, and remove the Float Bowl from the SmartCarb<sup>®</sup>. You may make any necessary adjustments at this time before cleaning the SmartCarb<sup>®</sup>.
- B.** Remove the POM float, float axle, and float needle and set them aside.
- C.** Follow step **1. Removing a Metering Rod** on Page 48 to remove and disassemble the slide and adjuster assembly. Set the assembly, metering rod, throttle return spring, and cable retainer aside.
- D.** Remove the cap from the throttle cable.
- E.** Gently clean the SmartCarb<sup>®</sup> body, Float Bowl, cap, and slide with hot, soapy water. If there is excessive oil residue and dirt, a soft-bristled toothbrush or Q-Tips may be used. Make sure all orifices are clear of obstructions. Rinse thoroughly with hot water.
- F.** Use compressed air to blow dry the SmartCarb<sup>®</sup> components.

#### **NOTE:**

Carb cleaner may be used, but avoid contact with rubber components including o-rings and the float needle. SmartCarb<sup>®</sup> carburetors and components, except for rubber items, are safe to use in a sonic cleaner.

- G.** Very gently wipe down, rinse, and blow dry the components that were set aside.
- H.** Reassemble the SmartCarb<sup>®</sup> after all parts are cleaned and dried. See Page 15 for steps on checking the needle valve prior to reinstalling the SmartCarb<sup>®</sup> on your vehicle.

# SmartCarb® Maintenance

## SmartCarb® Cleaning & Maintenance (continued)

### **2. Maintenance Requirements**

***NOTE:***

SmartCarb Fuel Systems recommends that SmartCarb® owners perform basic maintenance on their carbs to keep them running at optimum performance and to extend their longevity.

- A.** Clean your SmartCarb® seasonally, especially if the equipped vehicle has been stationary for awhile. Cleaning instructions are detailed on Page 55.
- B.** Drain the Float Bowl when the equipped vehicle will not be in use long-term or prior to storage. Use a fuel stabilizer if leaving fuel in the Float Bowl.
- C.** Replace service parts when worn out or about once every 18 to 24 months of moderate use. We recommend replacing the following service parts when necessary:
  - Fuel nozzle o-rings (2)
  - Throttle slide return spring
  - Cap Gasket
  - Float Bowl Gasket
  - Needle valve (3.8mm Viton-tip)

***NOTE:***

SmartCarb Fuel Systems has Rebuild Kits available for sale at \$50 on the Shop page at [smartcarb.com/shop](http://smartcarb.com/shop) that include the service parts listed above.



# Tuning Notes

## Record Clicks From Full Rich (CFFR) & Float Level Settings

# <b>CFFR</b>	<i>Fuel Level</i>
# <b>CFFR</b>	<i>Fuel Level</i>
# <b>CFFR</b>	<i>Fuel Level</i>
# <b>CFFR</b>	<i>Fuel Level</i>
# <b>CFFR</b>	<i>Fuel Level</i>
# <b>CFFR</b>	<i>Fuel Level</i>
# <b>CFFR</b>	<i>Fuel Level</i>
# <b>CFFR</b>	<i>Fuel Level</i>
# <b>CFFR</b>	<i>Fuel Level</i>
# <b>CFFR</b>	<i>Fuel Level</i>
# <b>CFFR</b>	<i>Fuel Level</i>
# <b>CFFR</b>	<i>Fuel Level</i>
# <b>CFFR</b>	<i>Fuel Level</i>
# <b>CFFR</b>	<i>Fuel Level</i>
# <b>CFFR</b>	<i>Fuel Level</i>
# <b>CFFR</b>	<i>Fuel Level</i>
# <b>CFFR</b>	<i>Fuel Level</i>
# <b>CFFR</b>	<i>Fuel Level</i>
# <b>CFFR</b>	<i>Fuel Level</i>
# <b>CFFR</b>	<i>Fuel Level</i>
# <b>CFFR</b>	<i>Fuel Level</i>
# <b>CFFR</b>	<i>Fuel Level</i>



# Tuning Notes

## General Notes

---

---

---

---

---

---

---

---

---

---

---

---

---

---

---

---

---

---

---

---

---

---

---

---

---

---

# SMART CARB®



## Contact

support@smartcarb.com  
+1 (816) 255 2328



@SmartCarb  
#smartcarbepipped

SmartCarb Fuel Systems, Inc  
9900 E 56th St  
Raytown, MO 64133  
USA

## Online Resources

Manuals, Videos, Guides, & More



[smartcarb.com/support/](https://smartcarb.com/support/)